

Verdrahtung Synthesizer
 общая прокладка приборов

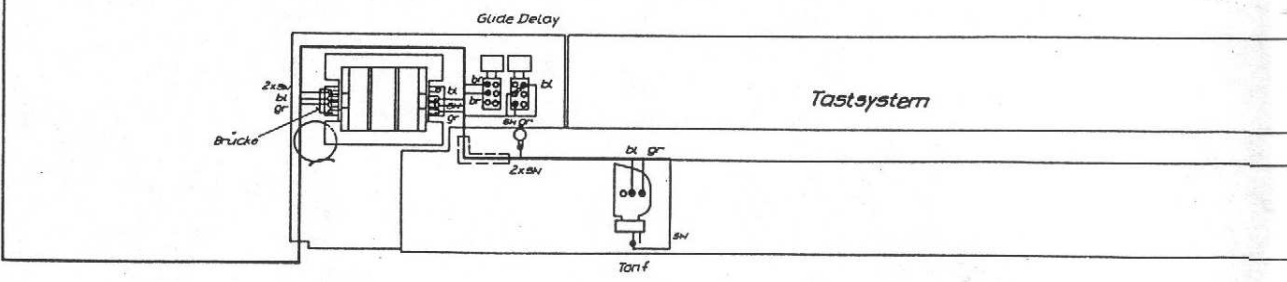

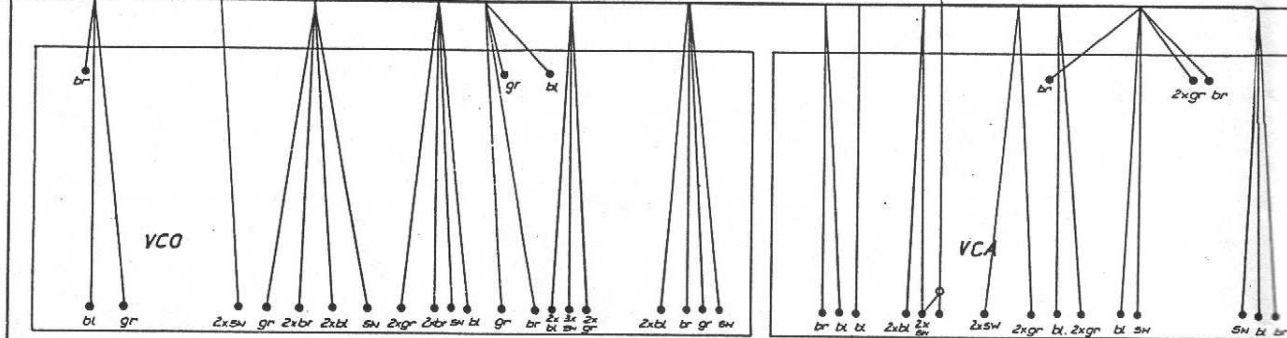

Gesamtstromlaufplan Synthesizer
 Общая коммутационная схема

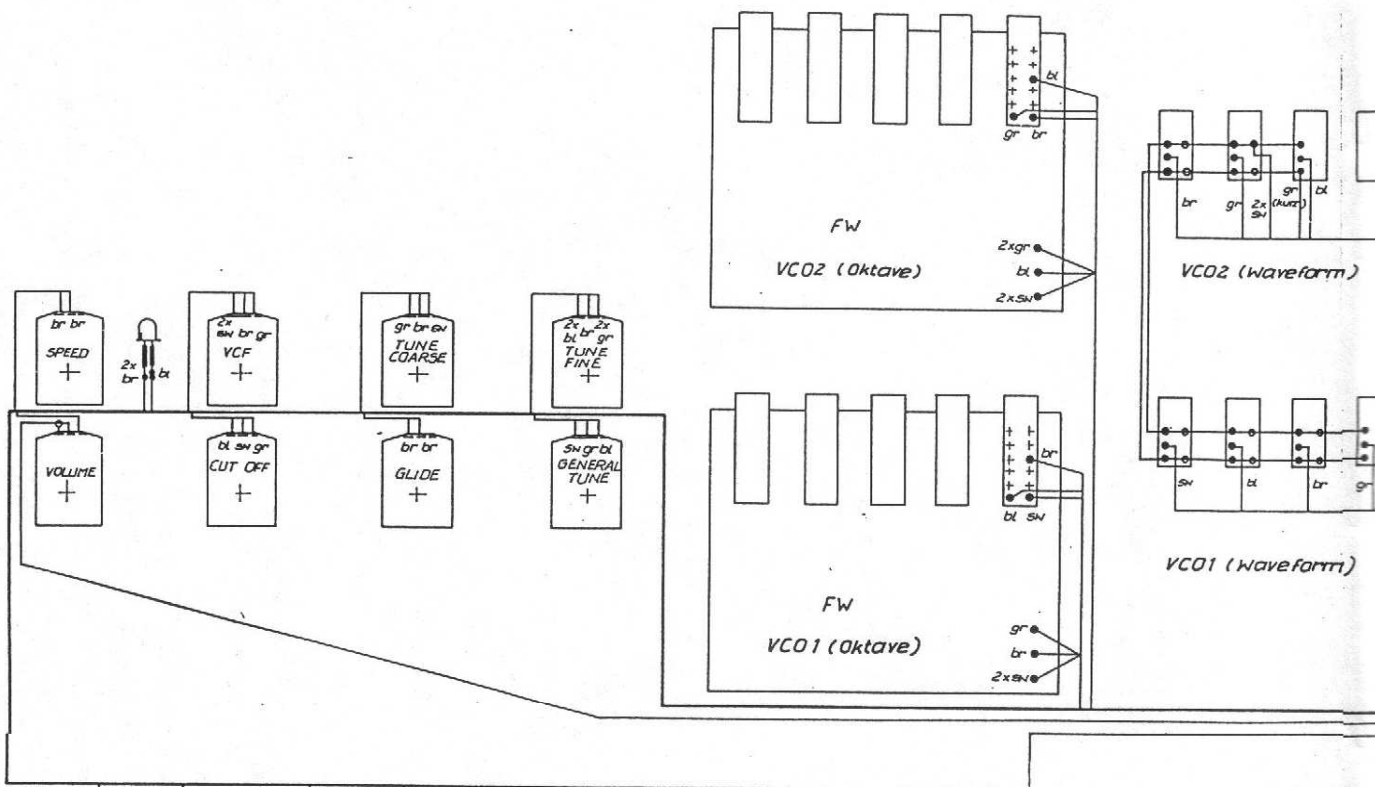
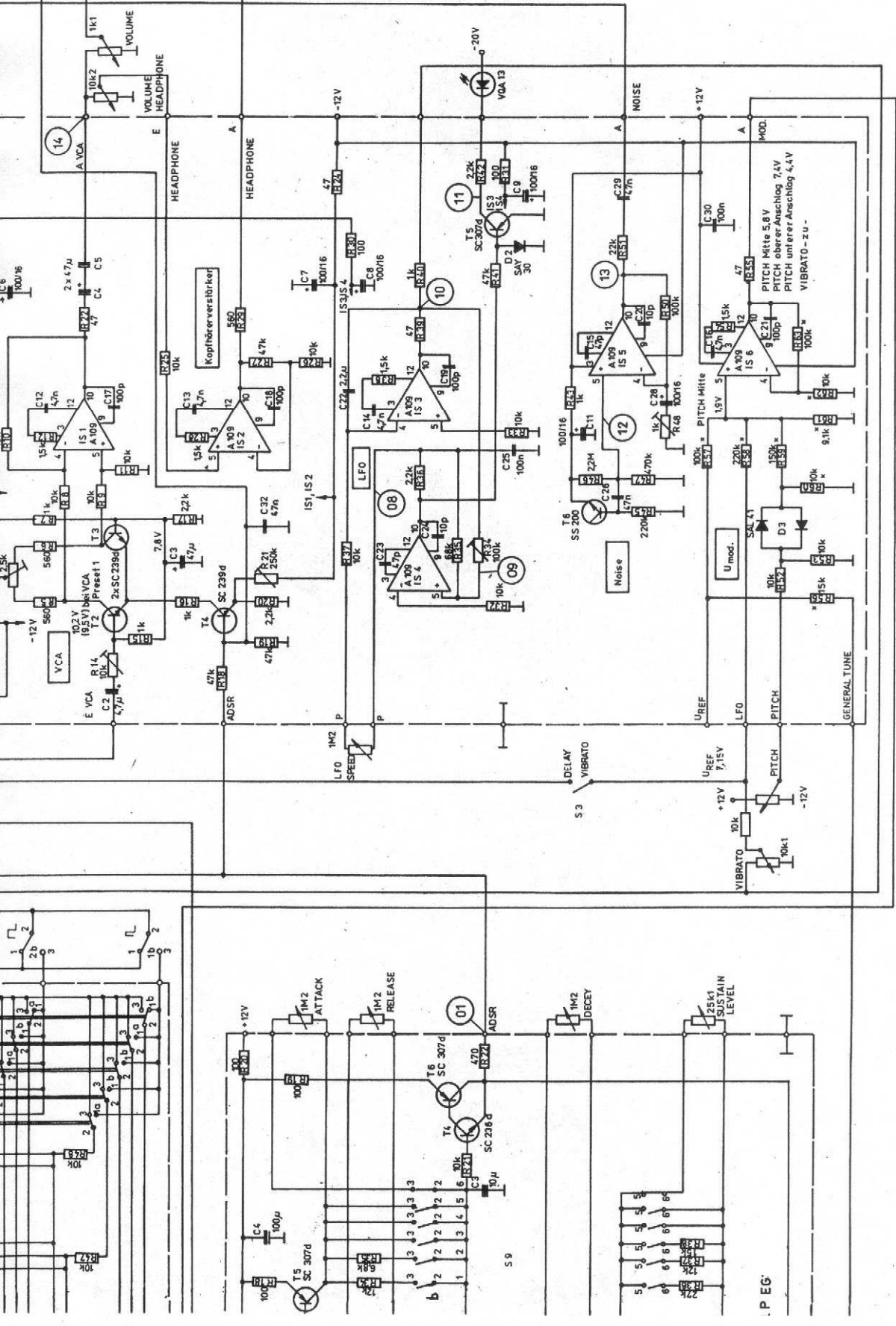
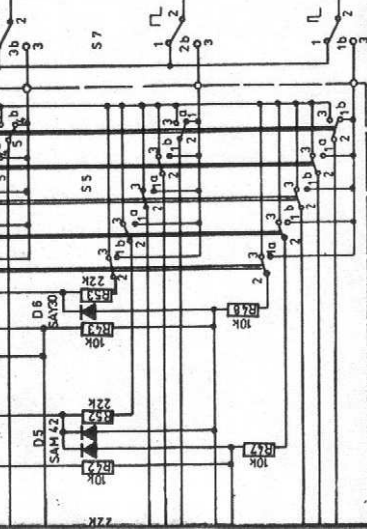
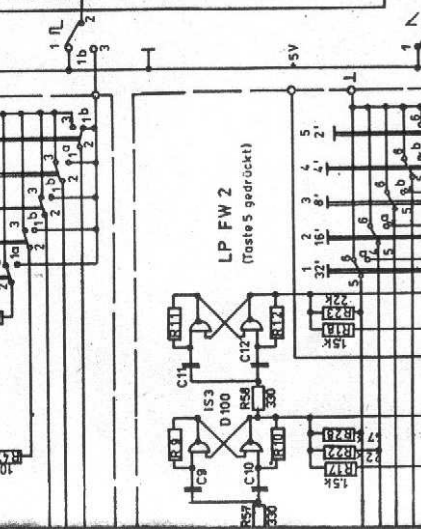
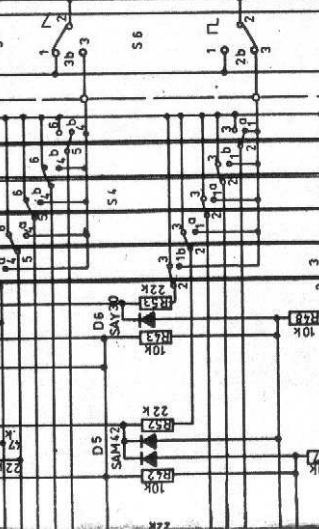
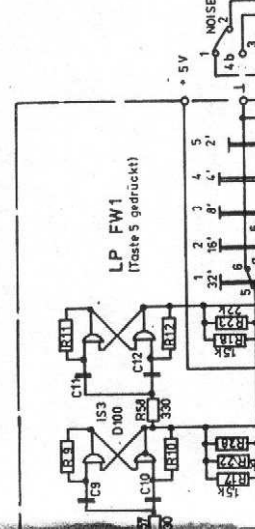
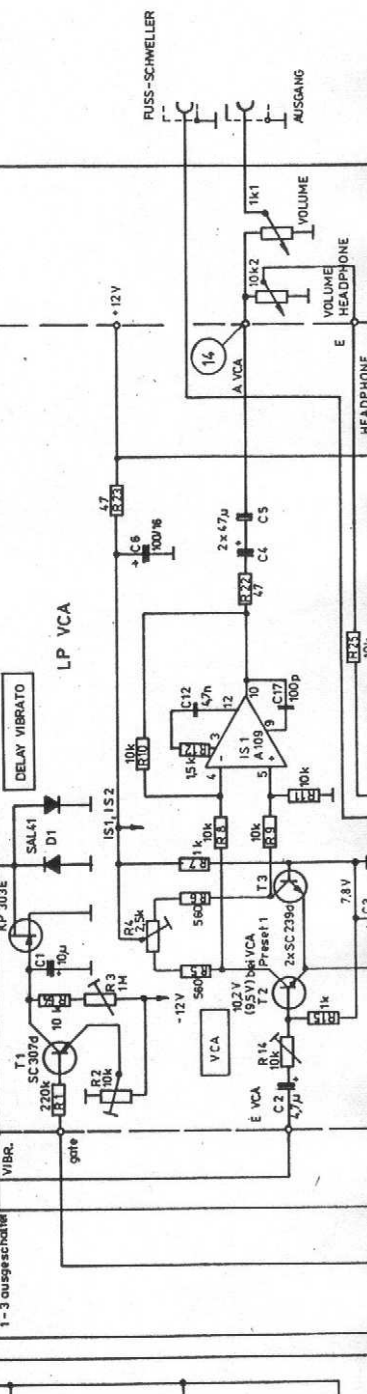
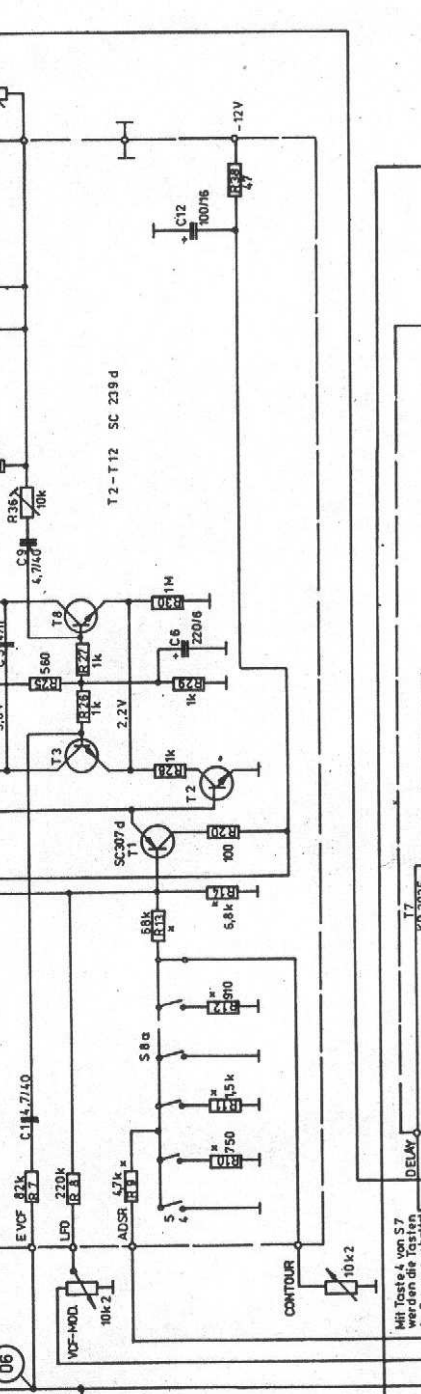
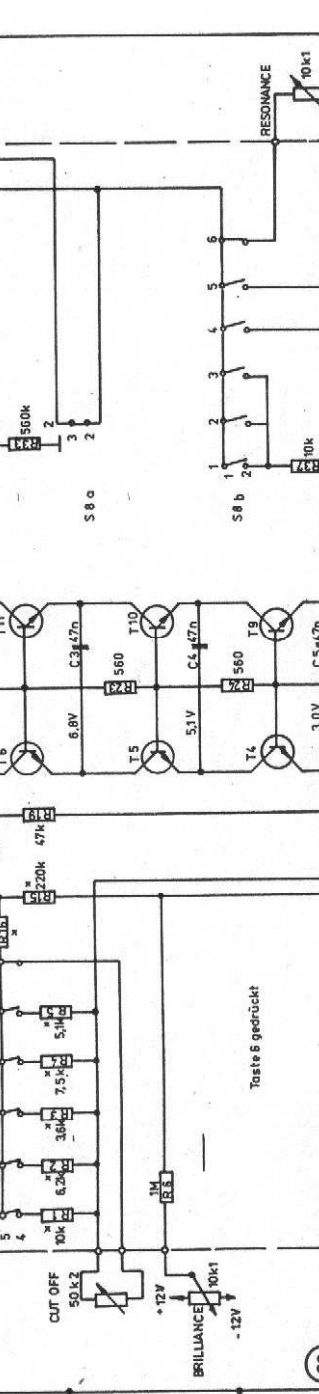
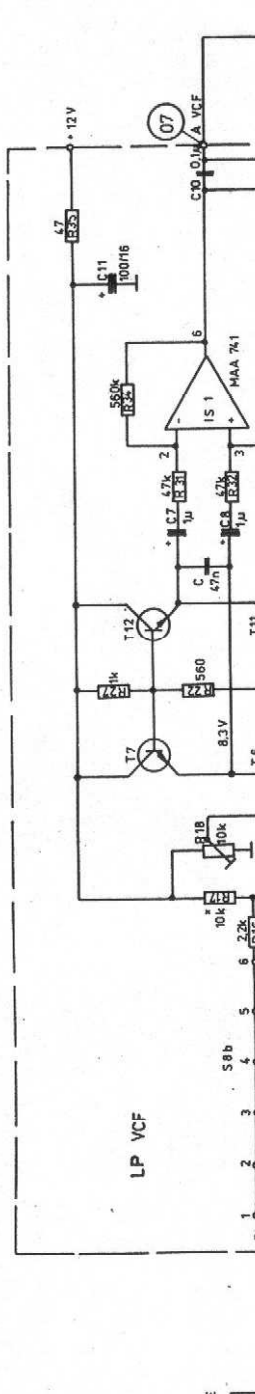
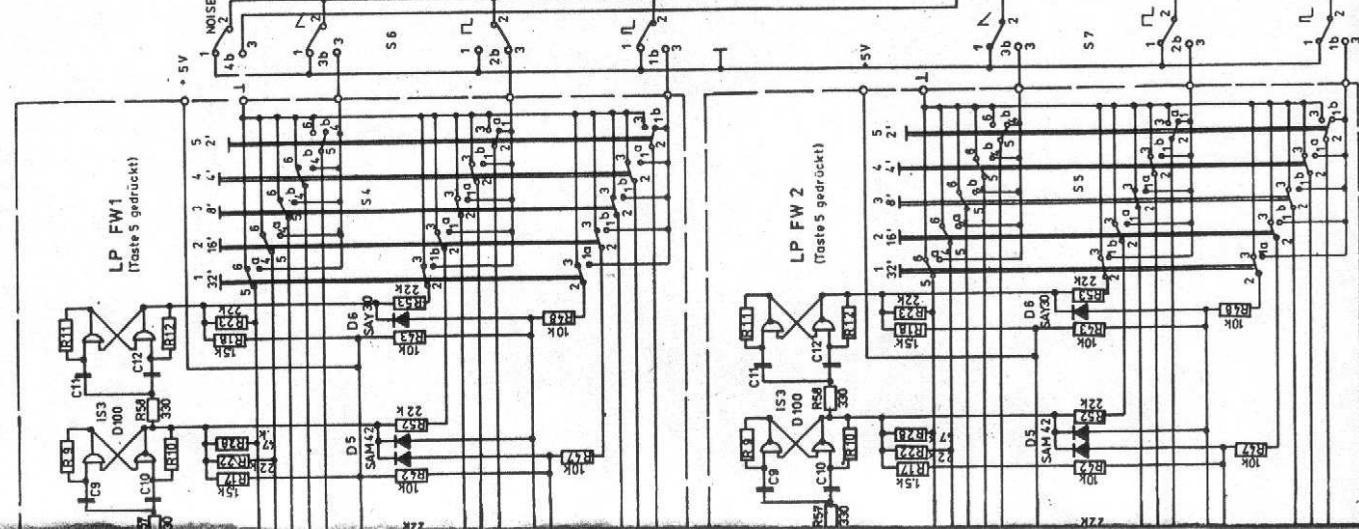
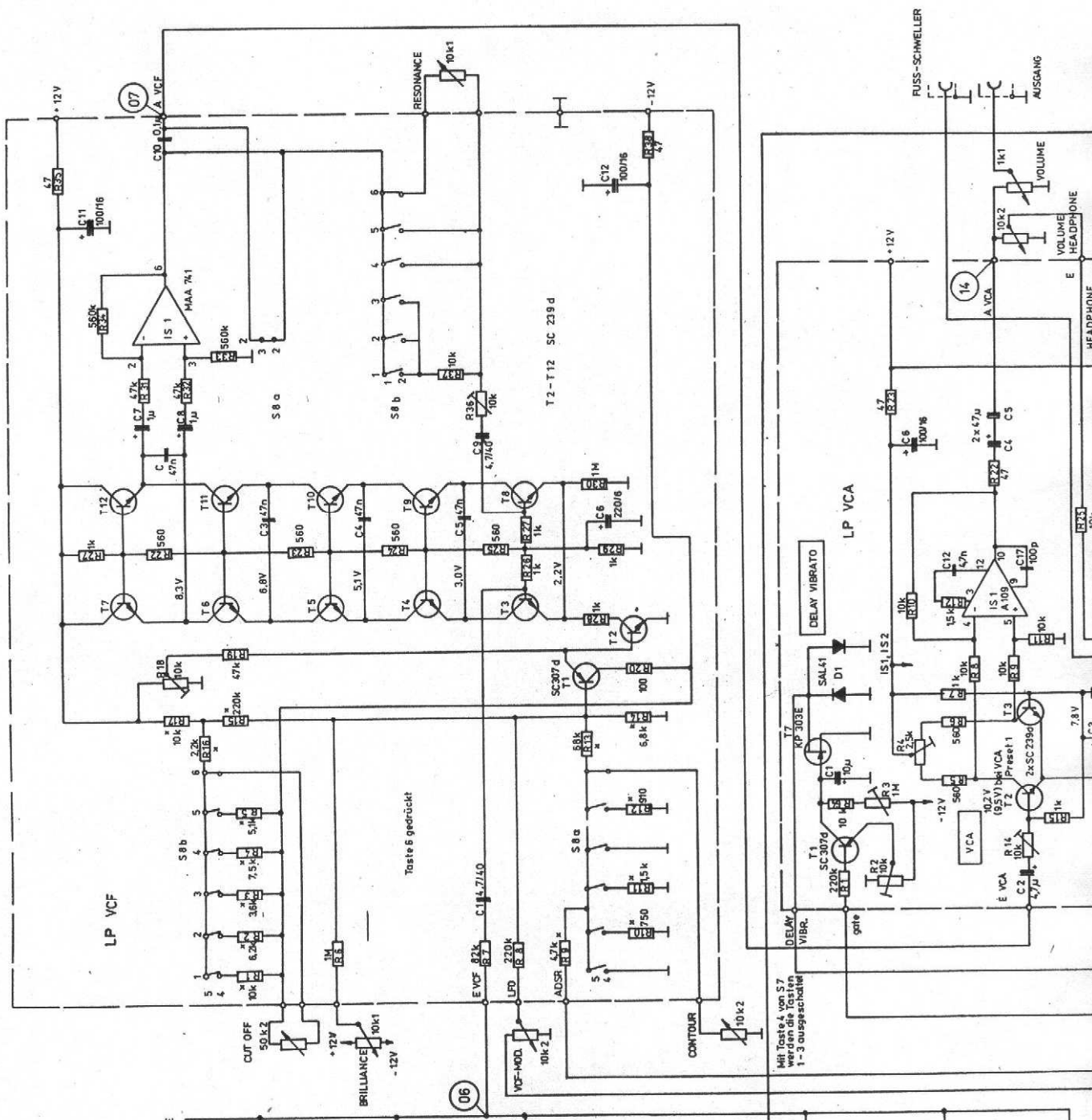

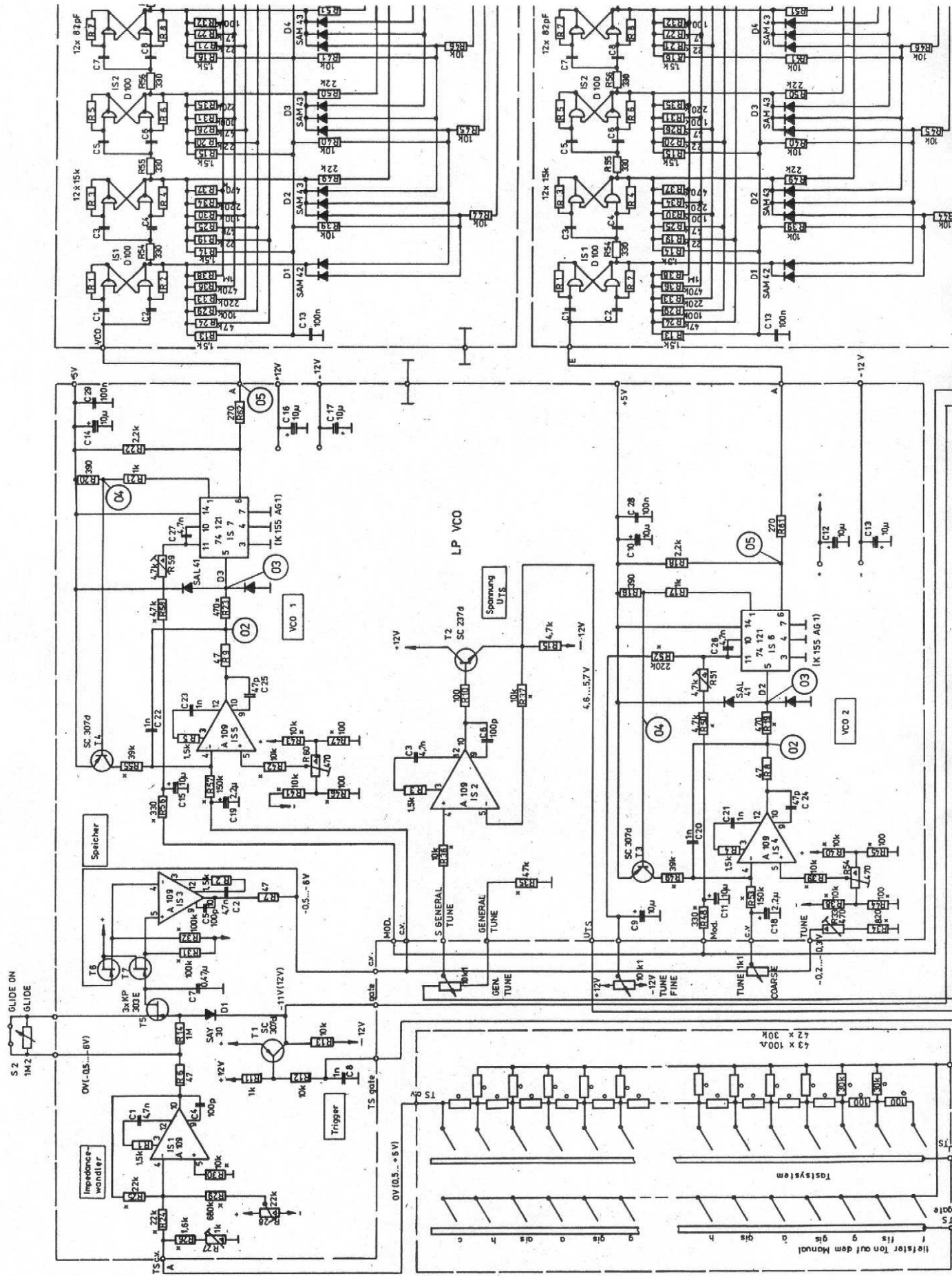

Hersteller Ton out dem Manual

Tastsystem

0V (0.5... +5V)

OV (-0.5... +6V)

GLIDE ON
1M2
GLIDE

TS gate

TS gate

TS gate

TS gate

TS gate

TS gate

TS gate

TS gate

TS gate

TS gate

TS gate

TS gate

TS gate

TS gate

TS gate

TS gate

TS gate

TS gate

TS gate

TS gate

TS gate

TS gate

TS gate

TS gate

TS gate

TS gate

TS gate

TS gate

TS gate

TS gate

TS gate

TS gate

TS gate

TS gate

TS gate

TS gate

TS gate

TS gate

TS gate

TS gate

TS gate

TS gate

TS gate

TS gate

TS gate

TS gate

TS gate

TS gate

TS gate

TS gate

TS gate

TS gate

TS gate

TS gate

TS gate

TS gate

TS gate

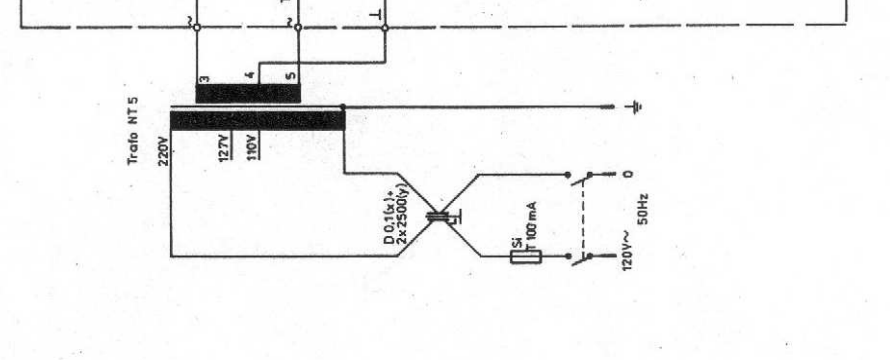
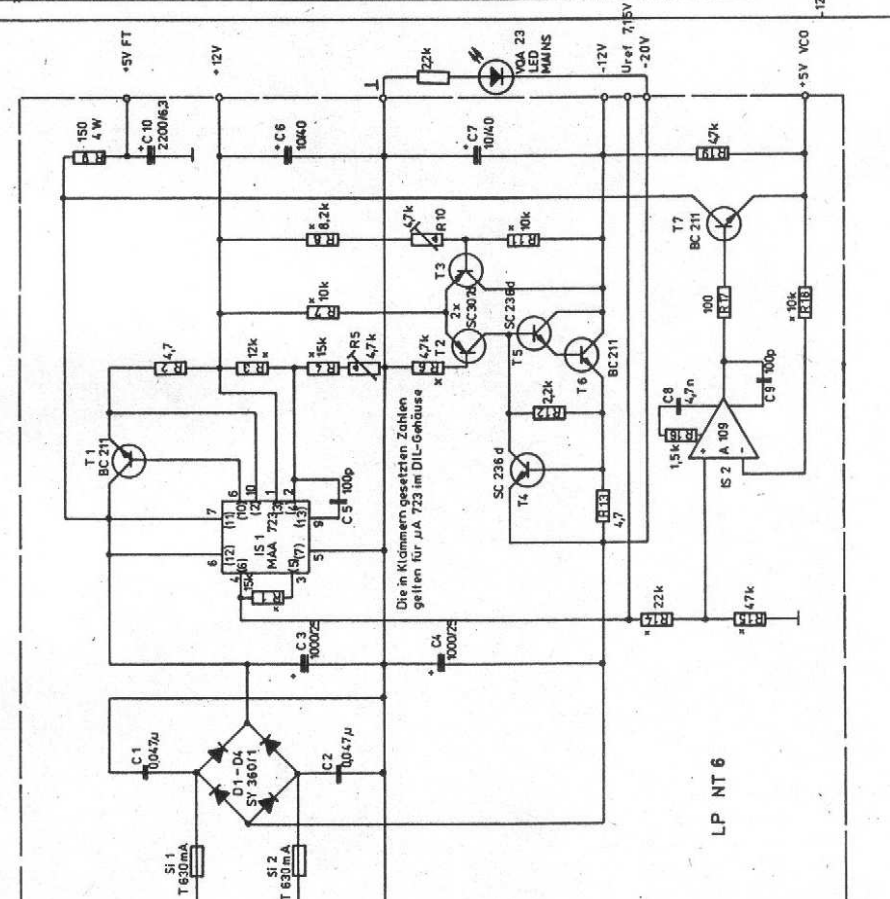
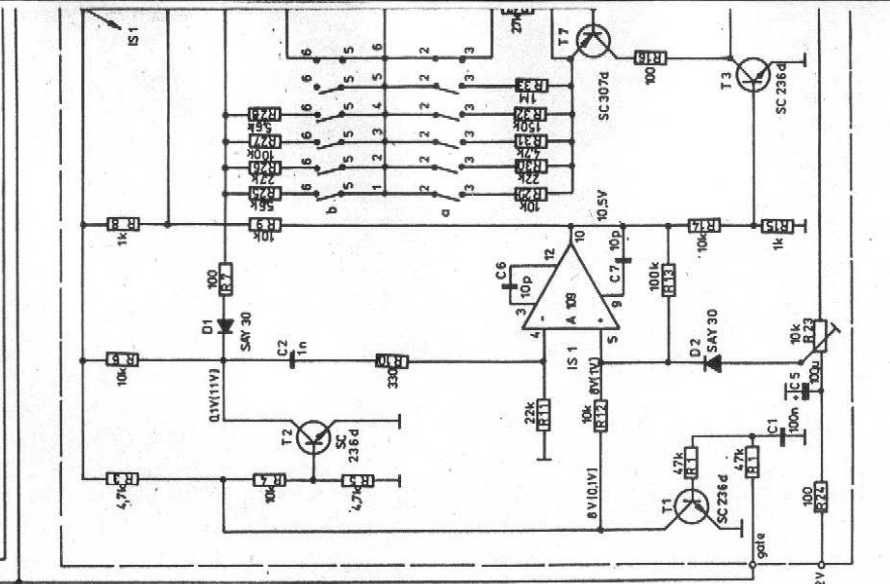
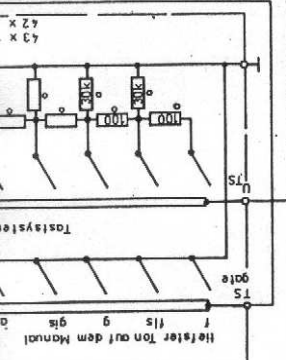
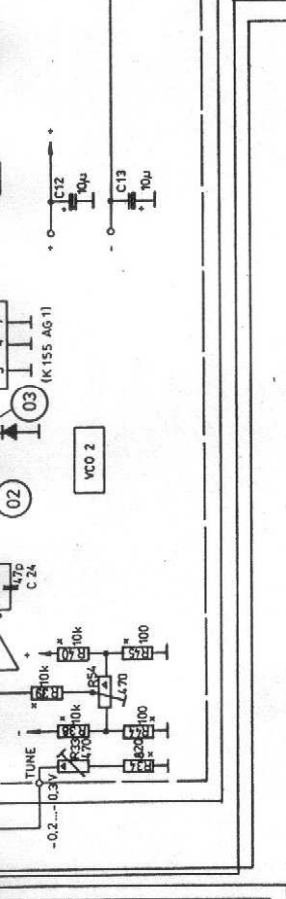
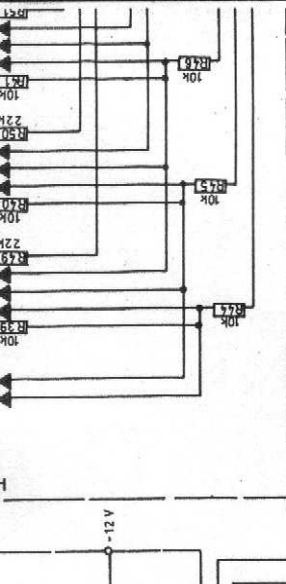

Die in Klammern gesetzten Spannungswerte gelten bei gedrückter Manualtaste.

- Baureihe 25.311 10%
- Baureihe 250.311 2%
- Baureihe 250.311 1%
- Baureihe 523.1313